

VEGAS 1

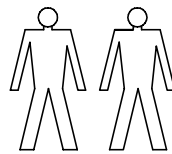

Narzędzia potrzebne do montażu

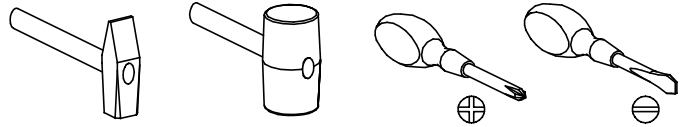

UWAGA !!!

MONTOWANIE USZKODZONYCH
ELEMENTÓW POWODUJE UTRATĘ
GWARANCJI

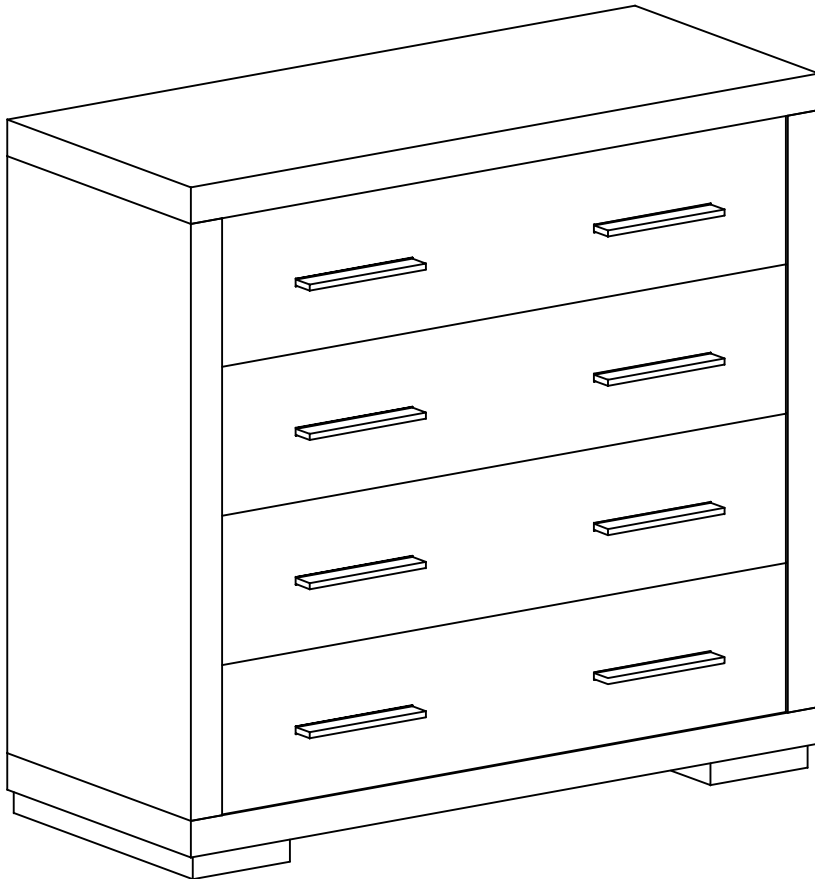

Nr	D[mm]	S[mm]	G[mm]	Ilość
1	971	407	48	1
2	971	407	48	1
3	783	405	48	1
4	783	405	48	1
5	960	834	2,5	2
6	865	190	16	4
7	350	165	16	4
8	814	165	16	4
9	350	165	16	4
10	844	355	2,5	4

W przypadku reklamacji proszę podać numer pakowacza znajdujący się na kartonie.

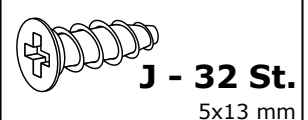
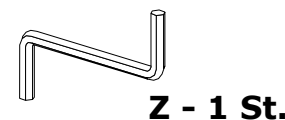
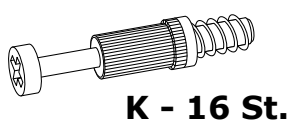
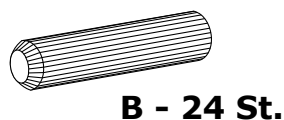
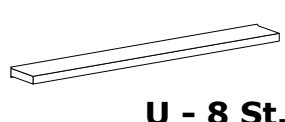
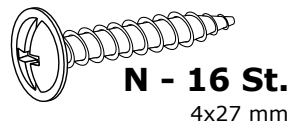
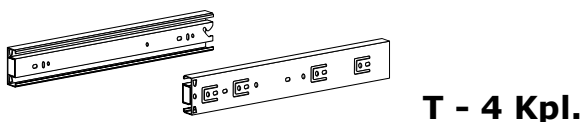
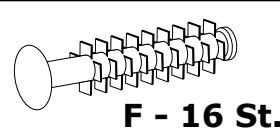
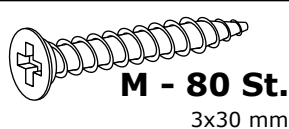
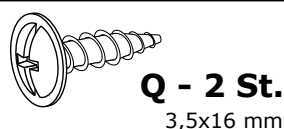
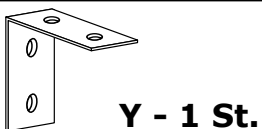
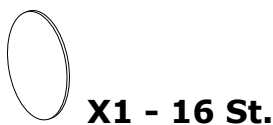
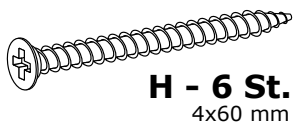

I

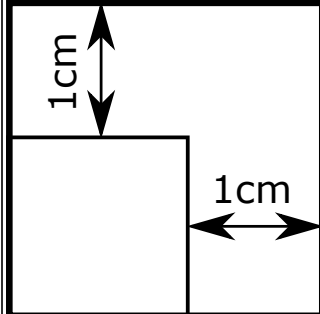
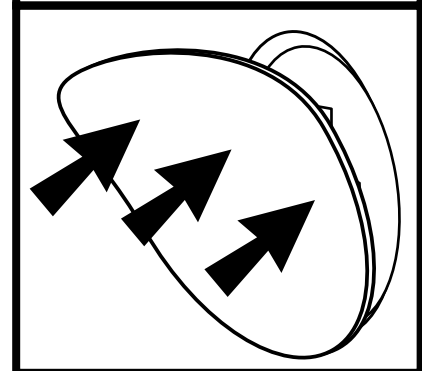
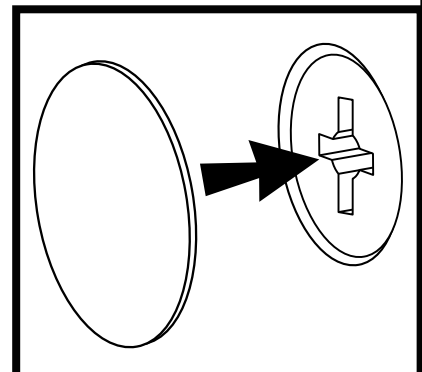
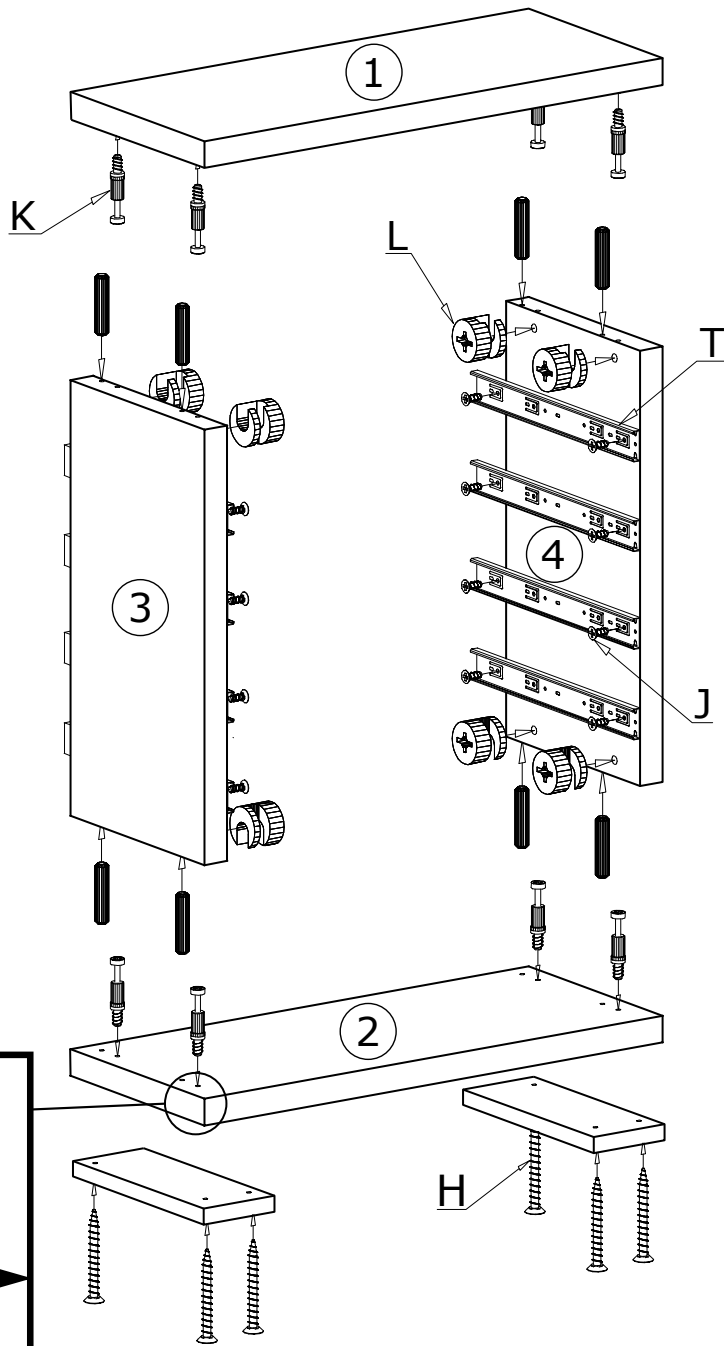

II

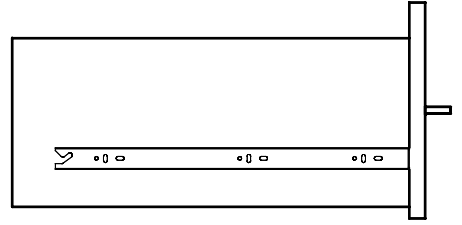
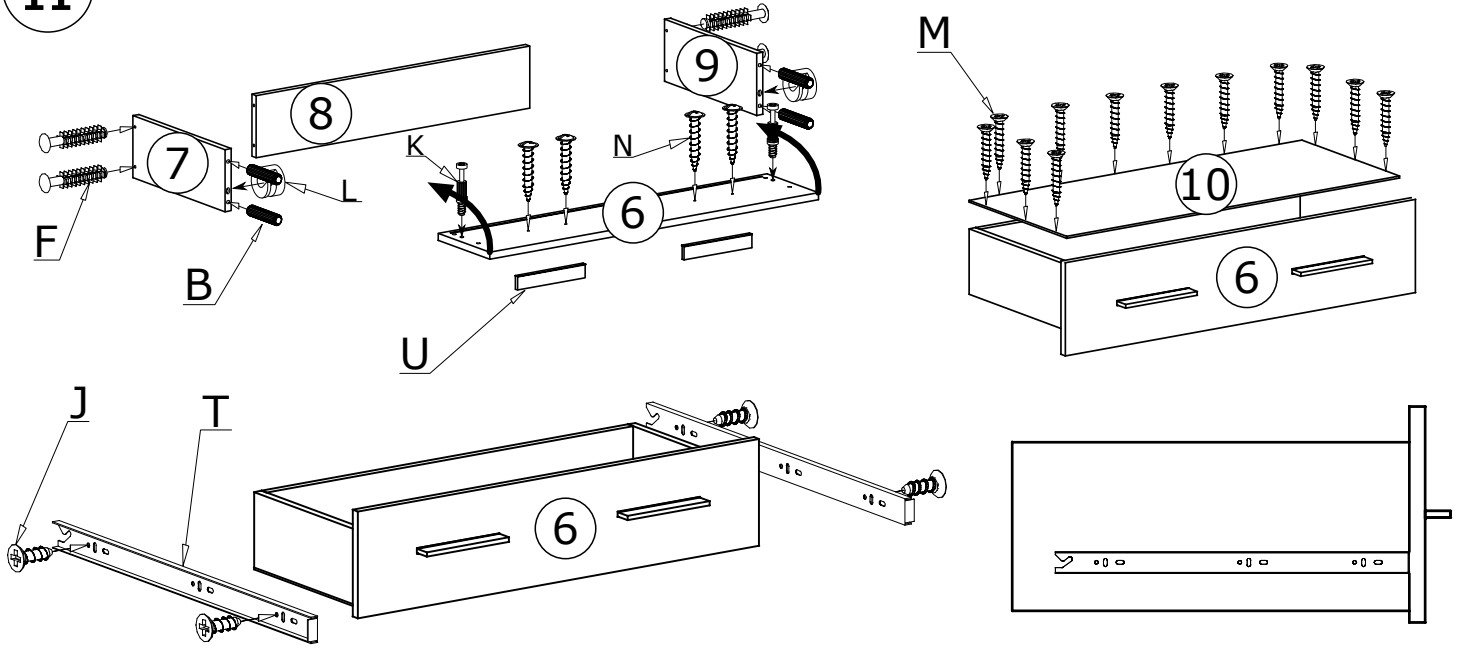

III

40X 

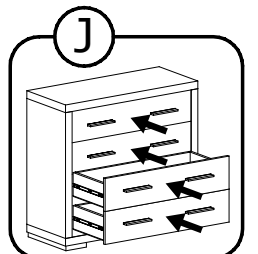
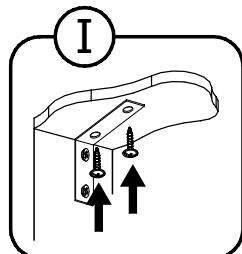
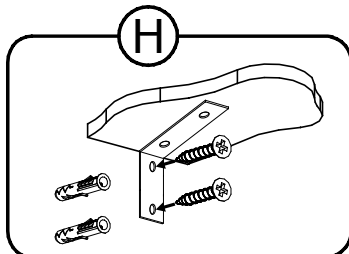
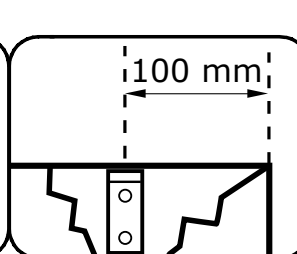
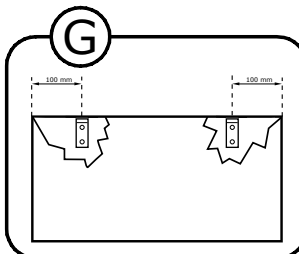
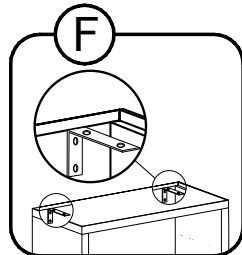
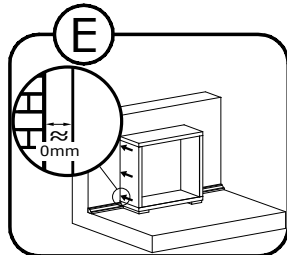
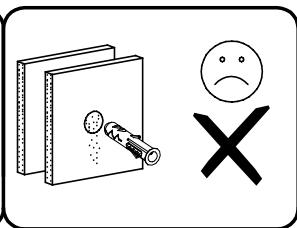
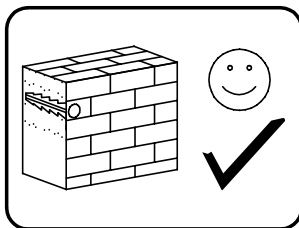
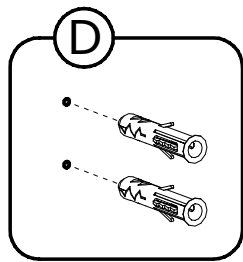
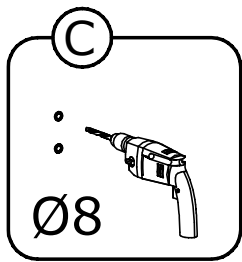
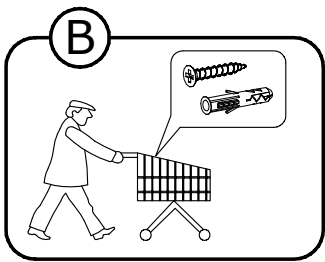
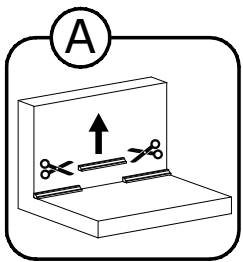
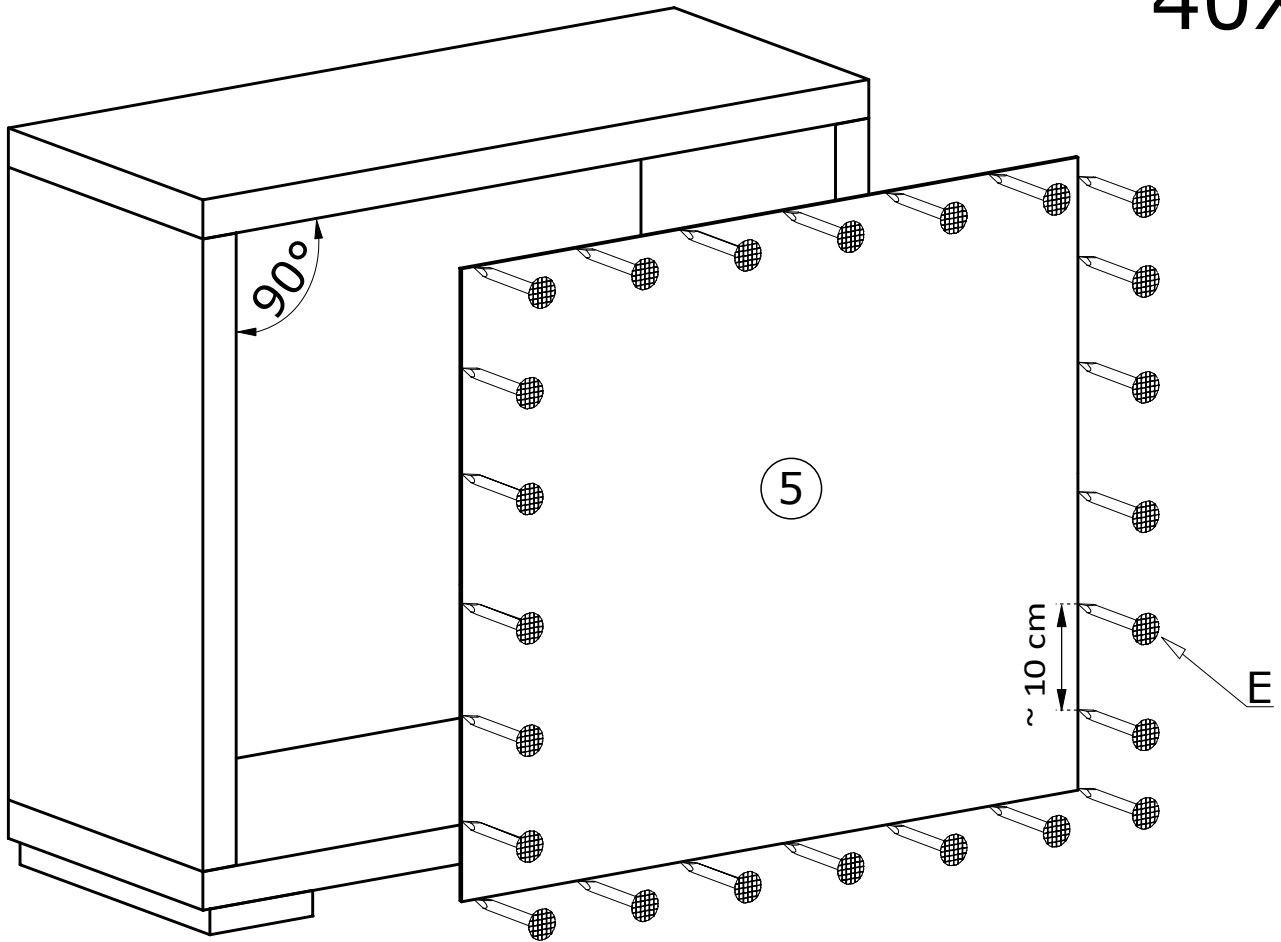

IV

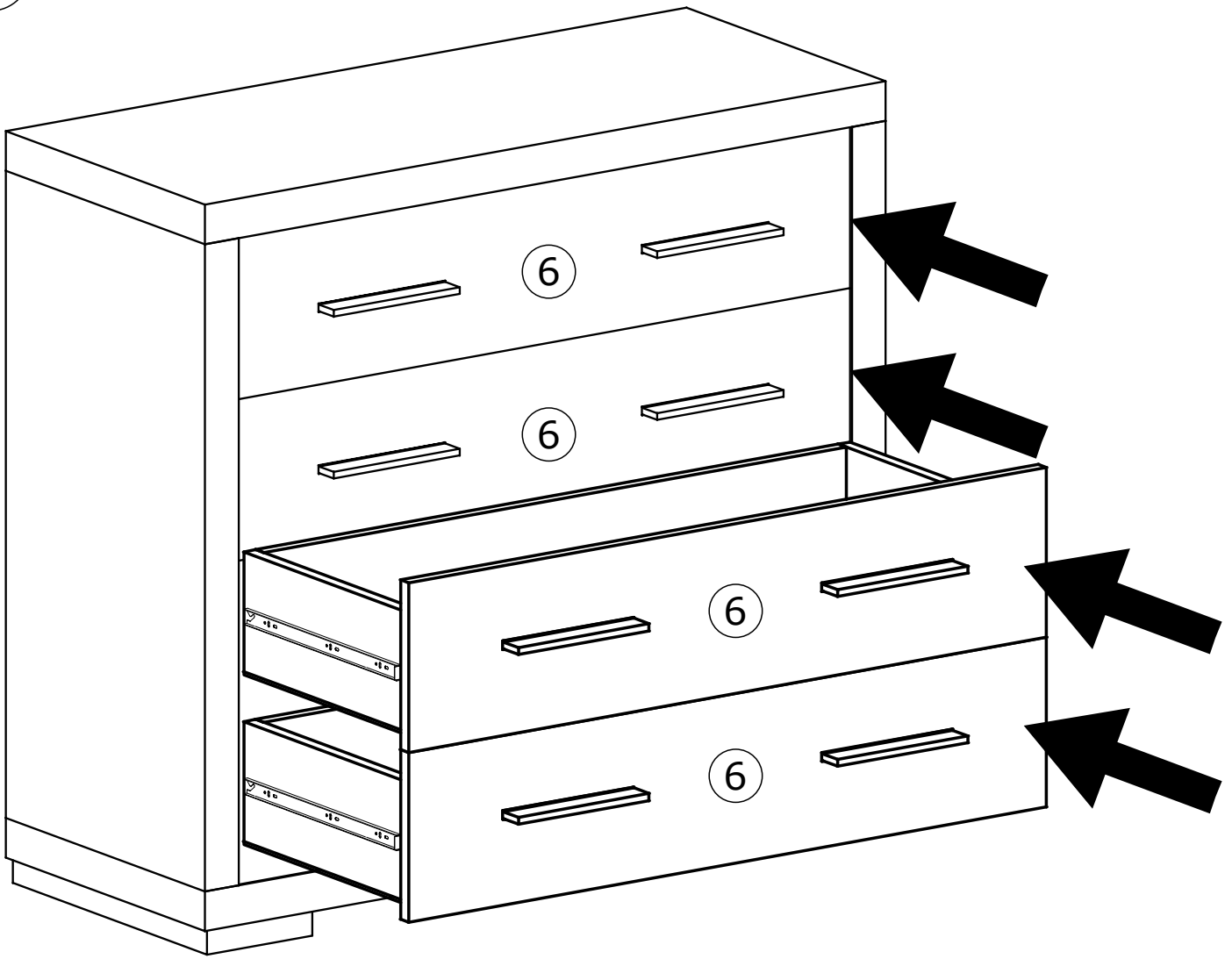

MONTAŻ/DEMONTAŻ PROWADNIC

1



2



3

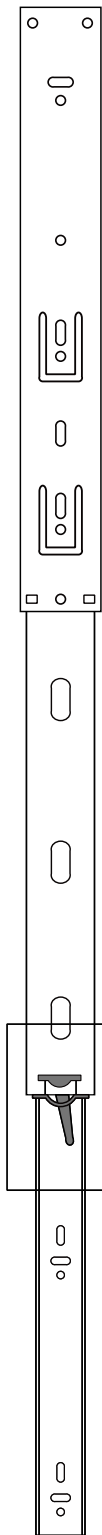

4

